

Data Sheet



Article number: 2311054631

Description: E+G Valve breather cap
SFV.20x1.5-10 mb

Measures

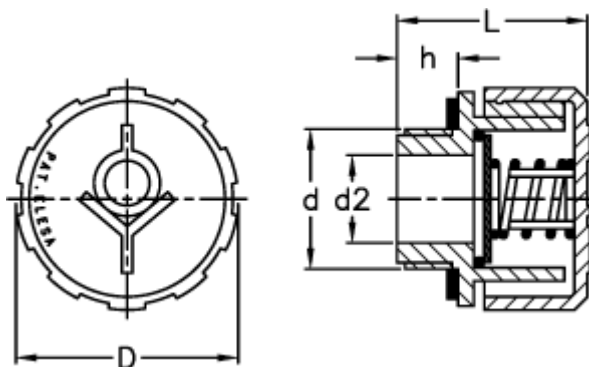

D = 31

d = M20x1,5

d2 = 10

h = 9.5

L = 29.5